

POWER DIODE MODULE

Features

- All the terminals and the mounting plate are electrically isolated. These modules can be installed in the same cooling fin as other modules, thus saving installation space – a cost-effective feature.
- The diode chips are coated with a glass of zinc oxide, making them highly resistant to temperature and humidity variation.
- 6 diode chips are connected to the 3-phase bridge rectifying circuit inside the module-a cost-effective feature.

Applications

- Inverters for AC motors
- Power supply units for DC motors
- DC power supply units for battery chargers
- General purpose DC power supply units

Maximum Ratings and Characteristics

Absolute Maximum Ratings

| Items | Symbols | Conditions | 6R130G | | Units |
|-------------------------------------|-----------|---|----------------|------|------------------|
| | | | -120 | -160 | |
| Repetitive peak reverse voltage | V_{RRM} | | 1200 | 1600 | V |
| Non-repetitive peak reverse voltage | V_{RSM} | | 1320 | 1760 | V |
| Average output current | I_O | 50/60 Hz Sinewave, $T_C = 88^\circ\text{C}$ | 30 | | A |
| Surge current | I_{FSM} | Rated load conditions | 320 | | A |
| I_t^2 | I_t^2 | Rated load conditions | 400 | | A ² s |
| Junction temperature | T_j | | -40~+150 | | °C |
| Storage temperature | T_{stg} | | -40~+125 | | °C |
| Tightening torque | | Mounting screw: M5 | 25±5 | | kg·cm |
| Vibration resistance | | | 5 | | G |
| Dielectric strength | | Between terminals and base | 2500 VAC 1 min | | |
| Net. Weight | | | 100 | | g |

Electrical Characteristics

| Items | Symbols | Conditions | Min | Typ | Max | Units |
|-----------------|-----------|---|-----|-----|------|-------|
| Forward voltage | V_{FM} | $T_j = 25^\circ\text{C}$, $I_{FM} = 30\text{ A}$ | | | 1.30 | V |
| Reverse current | I_{RRM} | $T_j = 150^\circ\text{C}$, $V_R = V_{RRM}$ | | | 30 | mA |

Thermal Characteristics

| Items | Symbols | Conditions | Min | Typ | Max | Units |
|---------------------------------------|---------------|--|-----|-----|------|-------|
| Thermal resistance (Junction to case) | $R_{th(j-c)}$ | 50/60 Hz Sinewave, Thermal resistance for total loss | | | 0.80 | °C/W |
| Thermal resistance | $R_{th(c-f)}$ | With thermal compound | | | 0.10 | °C/W |

Outline Drawings

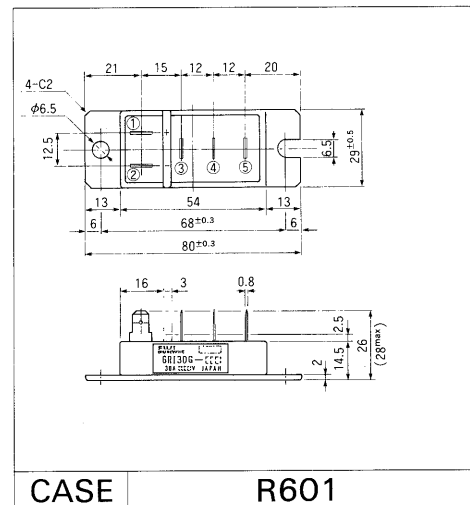

Inner Circuit Schematic

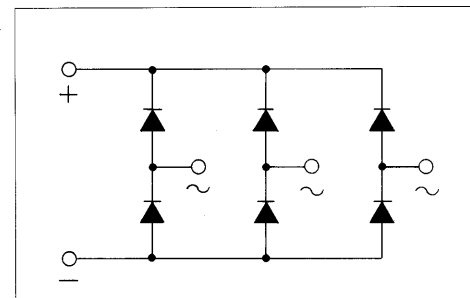

■ Characteristic curves

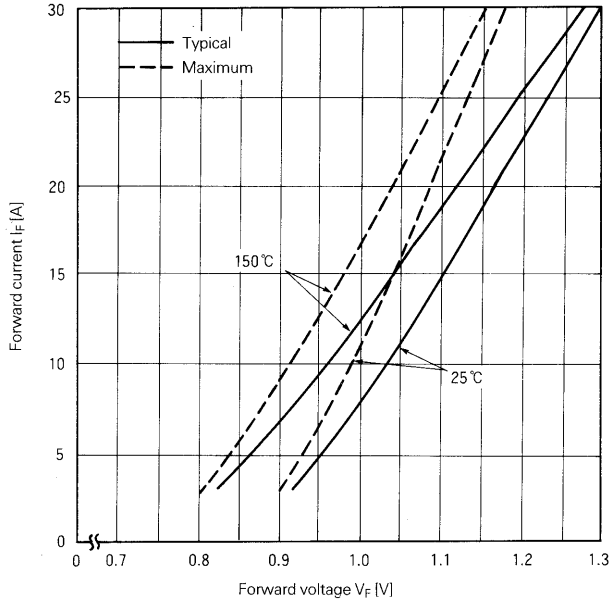

Forward Characteristics

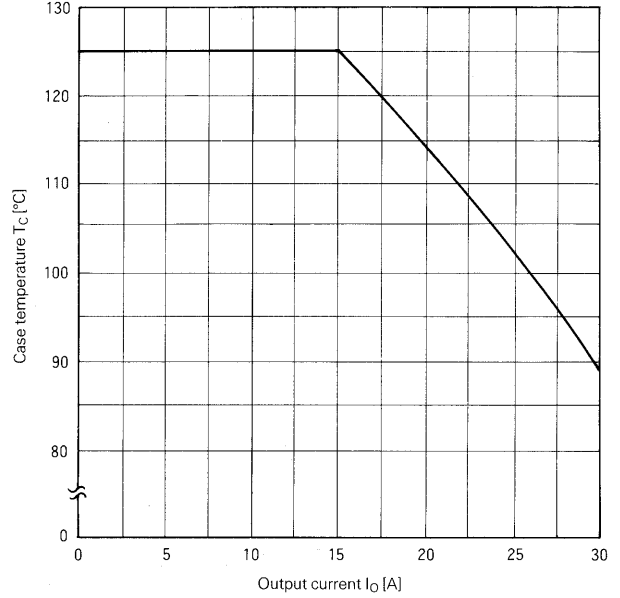

Case Temperature-Output Current

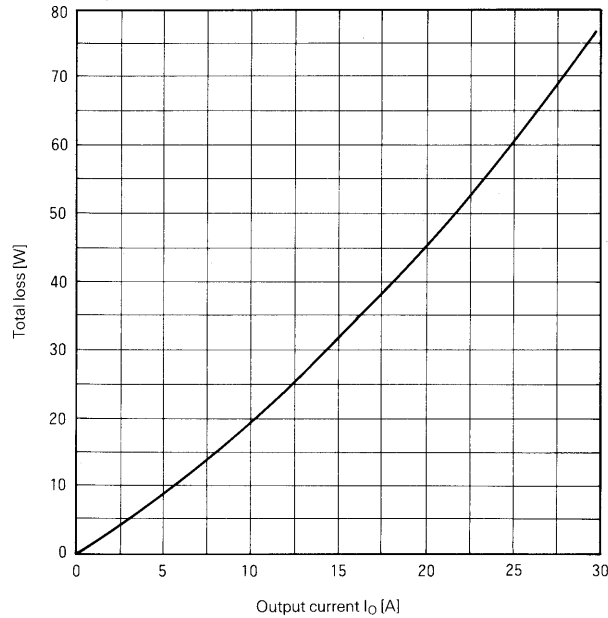

Output Current-Total Loss

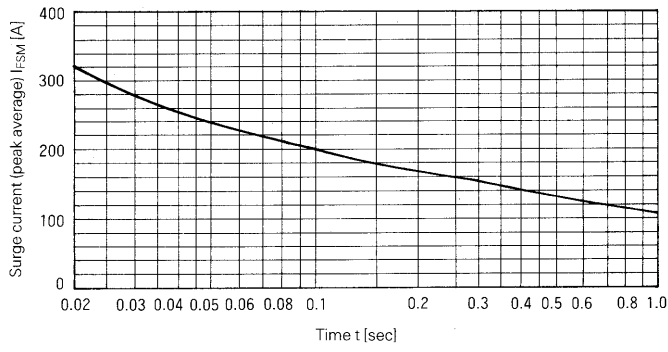

Surge Current

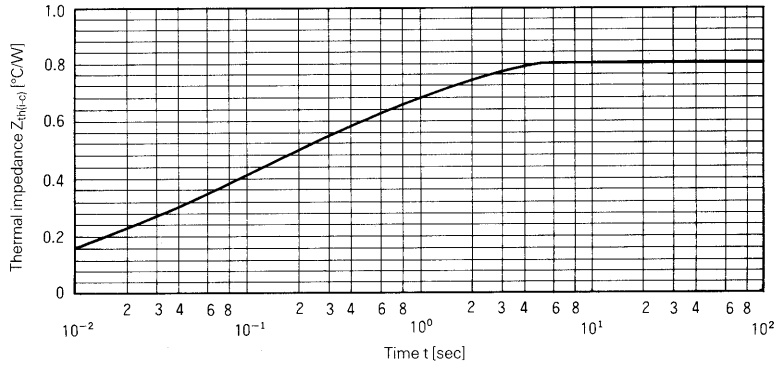

Transient Thermal Impedance

For more information, contact:

Collmer Semiconductor, Inc.

P.O. Box 702708

Dallas, TX 75370

972-733-1700

972-381-9991 Fax

<http://www.collmer.com>